

Future transport solutions
- the Volvo Group journey ahead

LARS STENQVIST

CHIEF TECHNOLOGY OFFICER, VOLVO GROUP

Volvo Group mission

Driving prosperity through
transport solutions



Focus on well-known *and* new technologies



Still a lot to explore in well-known technologies

THE FOUNDATION OF OUR BUSINESS FOR MANY YEARS TO COME



13L Turbo
Compound engine



Wave piston

RECENT EXAMPLES OF PERFORMANCE IMPROVEMENTS

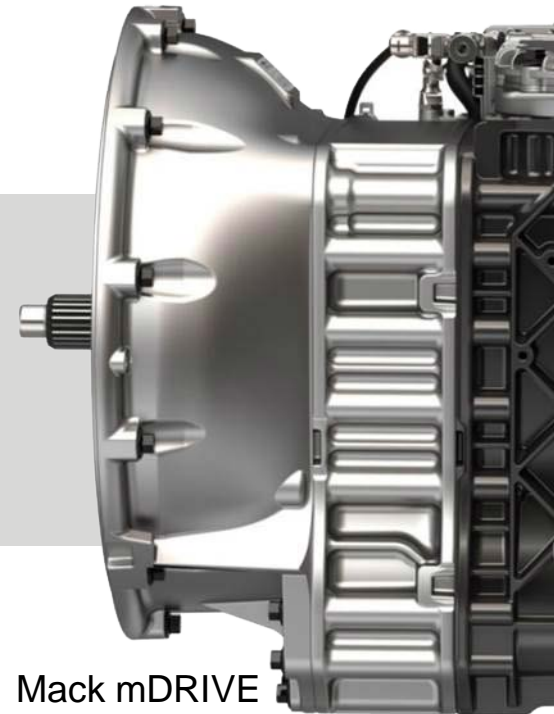

Mack mDRIVE
creeper gear ratios

New technologies: On our way

TODAY'S OFFER

FUTURE SOLUTIONS

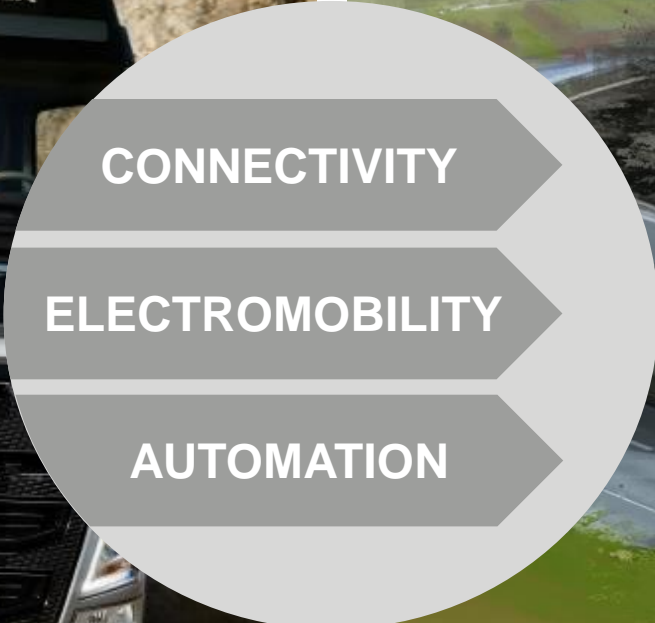
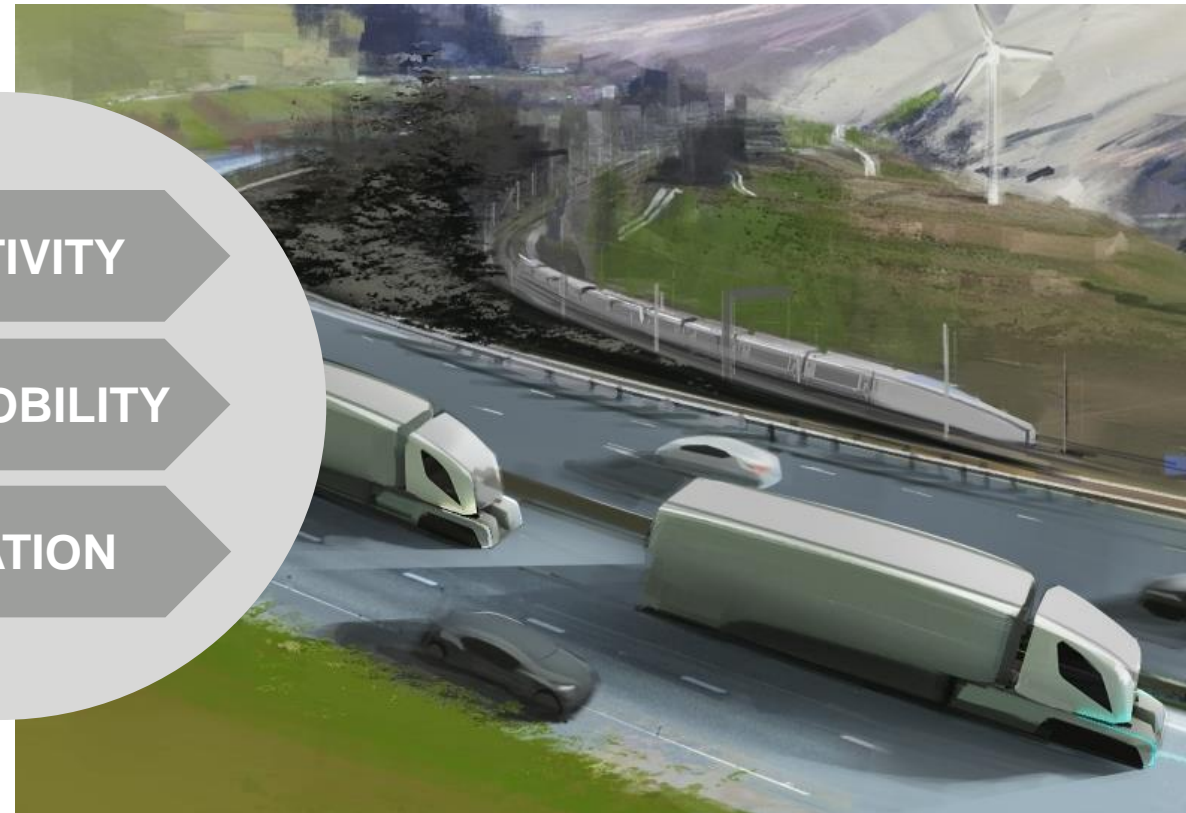

600,000 connected vehicles

ENABLER OF NEW PRODUCTS & SERVICES AND NEW WAYS OF WORKING

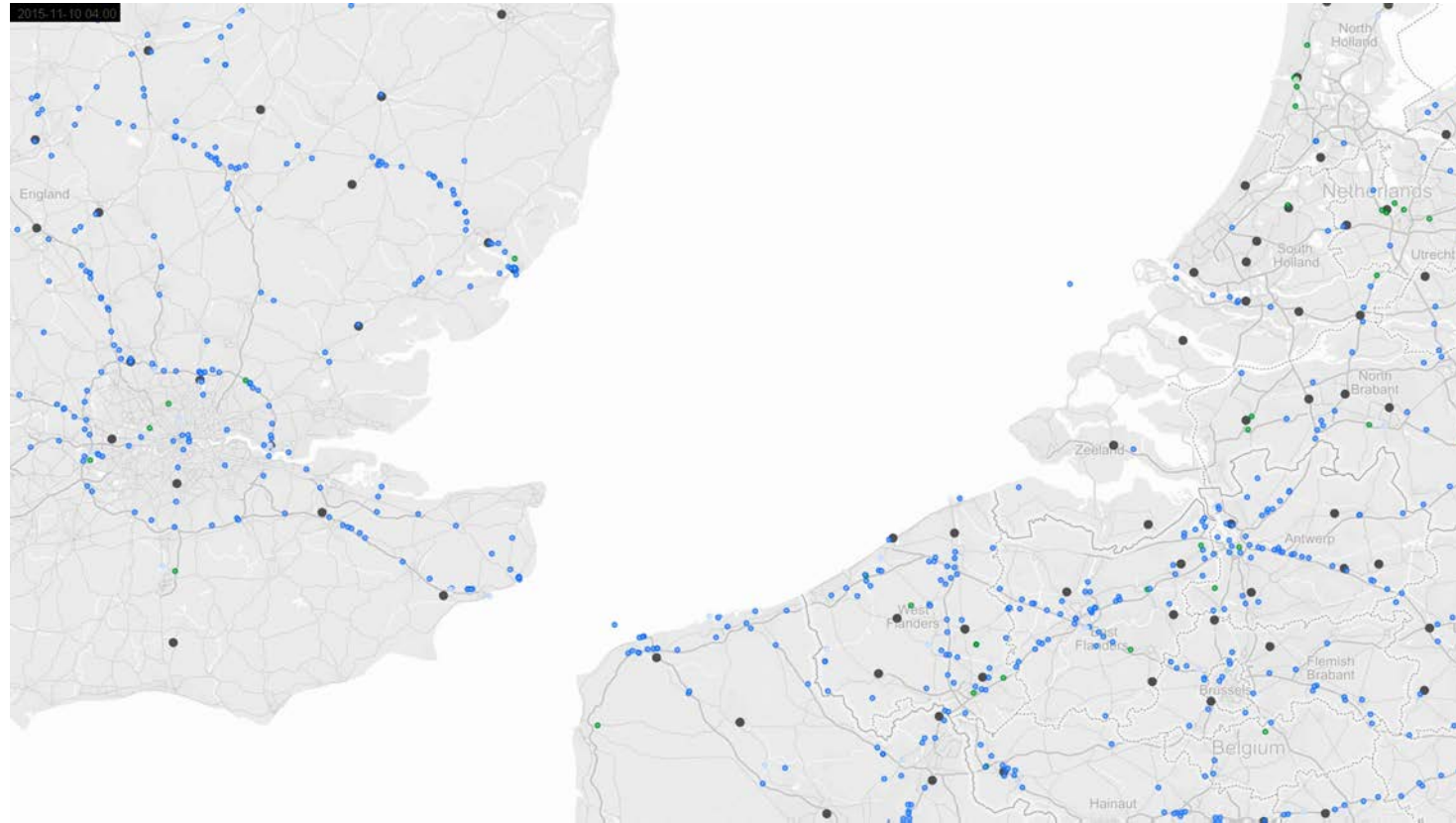
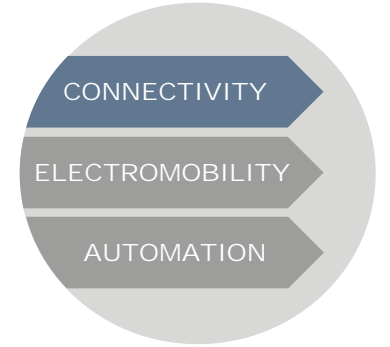

Connected vehicles Western Europe – real data

Competitive edge in electromobility

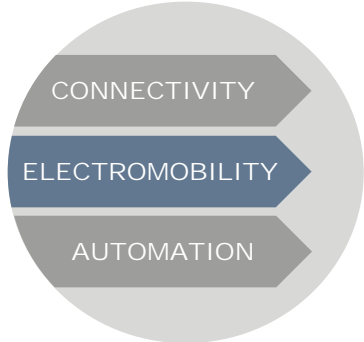

HYBRID BUSES



ELECTRIC HYBRID BUSES



FULL ELECTRIC BUSES

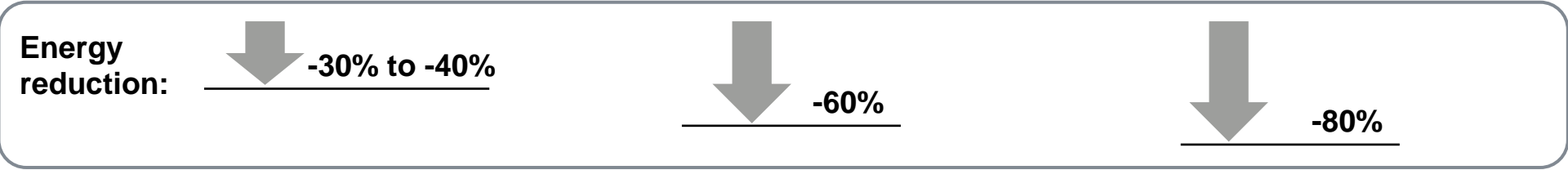

Truck electrification – next steps

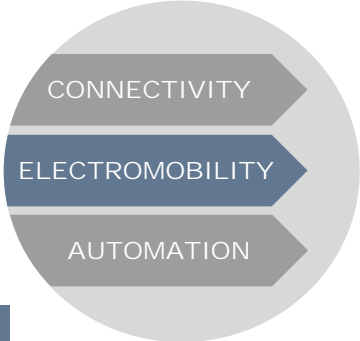

FULL ELECTRIC



HYBRID SOLUTIONS



ELECTRIC HIGHWAYS



Construction equipment electrification

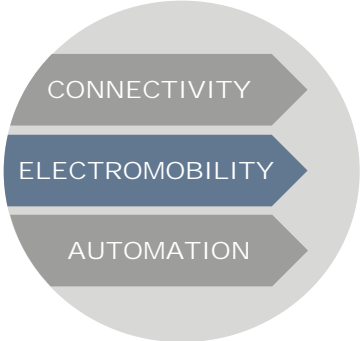

HYBRID SOLUTIONS



FULL ELECTRIC



Automation levels over time - stepwise

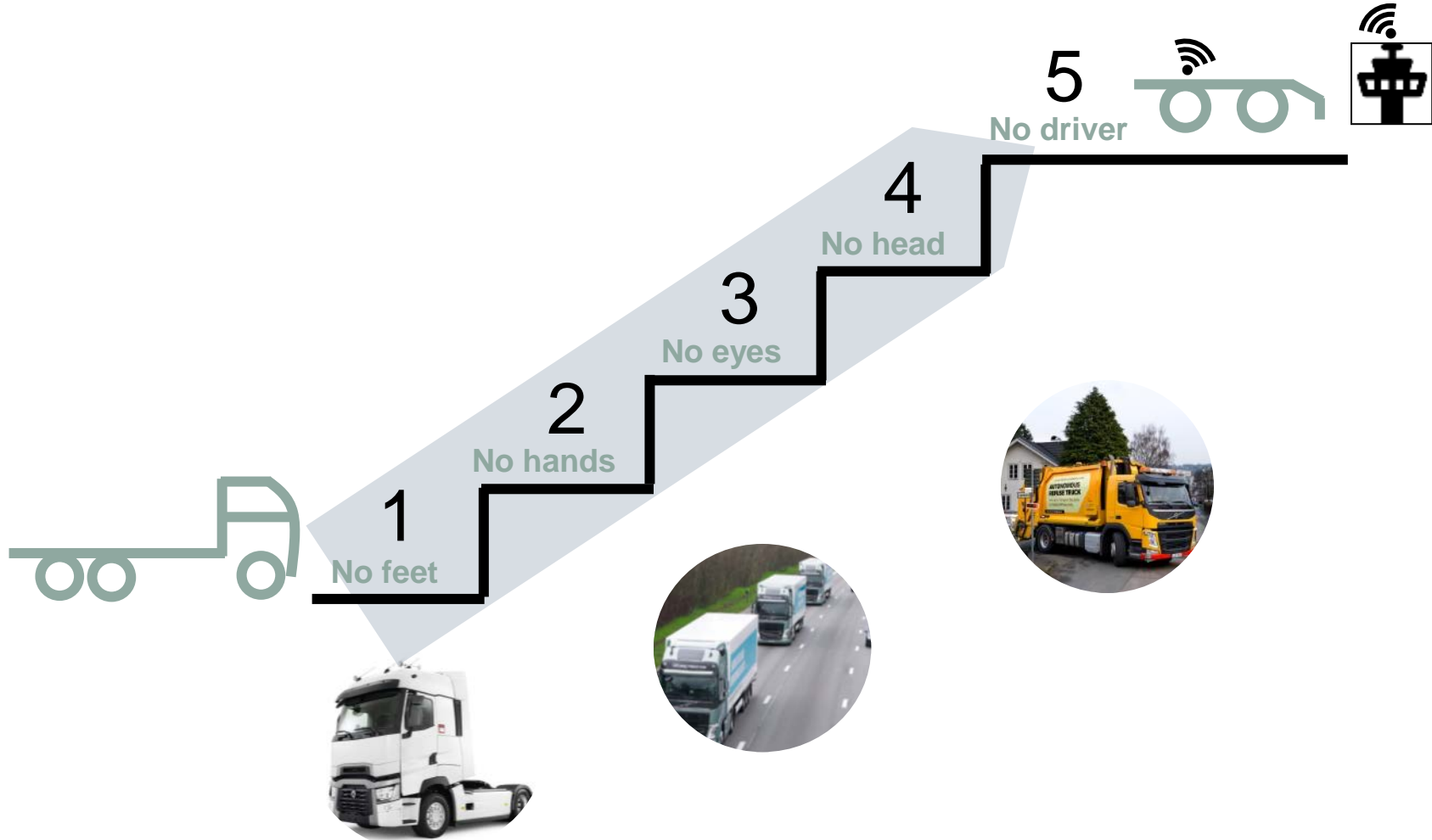

CONNECTIVITY

ELECTROMOBILITY

AUTOMATION

All three technologies converging

HIGHLY EFFICIENT AND INTEGRATED TRANSPORT SYSTEM

CONNECTIVITY

ELECTROMOBILITY

AUTOMATION



Volvo Group Trucks Technology

Lars Stenqvist

11 June 2017

VOLVO

Collaboration and partnerships: The way forward

